

# MODEL: API3CS3838A5T

ALL ACCESSORIES OPTIONAL



PERSPECTIVE VIEW - N.T.S.  
MODEL SHOWN HERE AS:

RIGHT SEAT  
LEFT PLUMBING

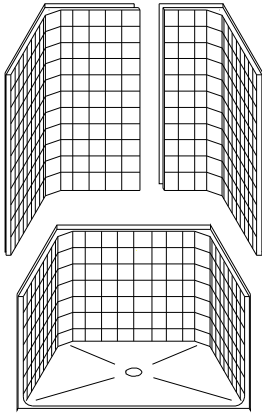

ASSEMBLY VIEW - N.T.S.

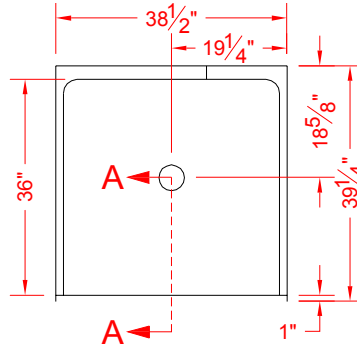

TOP VIEW - SCALE  $\frac{3}{8}'' = 1'-0''$

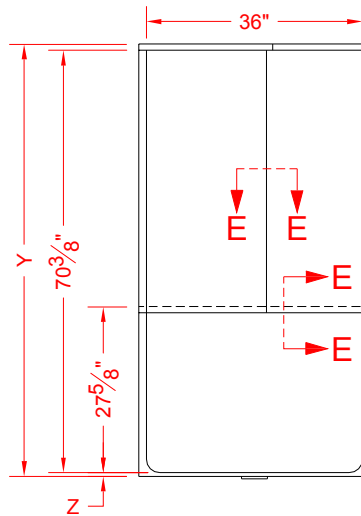

FRONT ELEVATION - SCALE:  $\frac{3}{8}'' = 1'-0''$



## Features:

- Molded, ADA compliant three piece gelcoat/fiberglass transfer shower
- Available in various threshold heights
- "Classic Tile" wall finish, white (standard)
- Integral full wood backing for strength and unlimited accessory placement
- On all threshold, heights 1-1/2" or taller, no mud set is required
- On all threshold, heights 1-1/4" or shorter, no mud set is required, but an epoxy adhesive kit is supplied

## \*OTHER THRESHOLD HEIGHTS AVAILABLE UPON REQUEST

	UNIT HEIGHT	THRESHOLD HEIGHT
MODEL #	Y	Z*
API3CS3838A5T	72"	5/8" MIN.

\* - SEE BACK FOR DETAIL SECTIONS

## PRODUCT SPECIFICATIONS:

- Multi piece shower module shall be constructed of gelcoat/fiberglass with full integral plywood backing
- Rough-In: Stud opening +1/4" -0" Nominal Dimensions.

## PRODUCT INFORMATION:

## ACCESSORIES:

### INSTALLED BY OTHERS:

- Grab bar
- Seat, folding
- Mixing valve, pressure balanced, lever handle, preplumbed tree to supply elbow
- Vacuum breaker
- Soap dish
- Curtain and rod
- Collapsible Rubber Water Retainer
- Semi-permanent Threshold Adaptor
- Caulkless drain

## CODES:

- Designed and manufactured in compliance with the following standards and codes:
- A.N.S.I. Z124.2 Standards for Plastic Showers
  - I.P.C. International Plumbing Code
  - A.D.A. Accessibility Guidelines for Buildings and Facilities
  - A.N.S.I. A117.1 Accessible and Usable Buildings and Facilities
  - U.P.C. Uniform Plumbing Code

## NOTICE OF LIMITATION:

- Recess as needed to meet code
- Adhere to floor as required

1-877-947-7769

www.Accessible-Bathrooms.com

We reserve the right to make revisions without notice in the design of fixtures or in packaging unless this right has specifically been waived at the time the order is accepted.

□ API3CS3838A5T

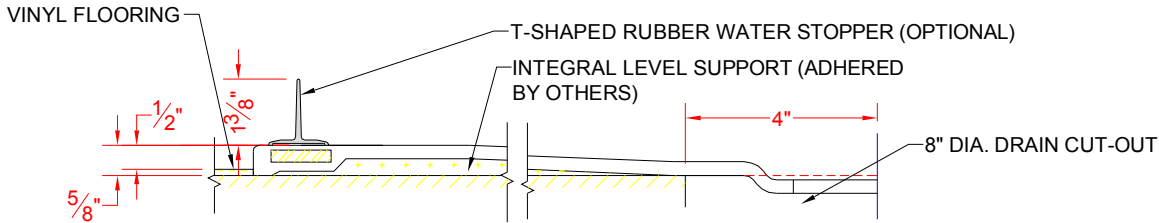

SECTION A-A - SCALE: 3" = 1'-0"

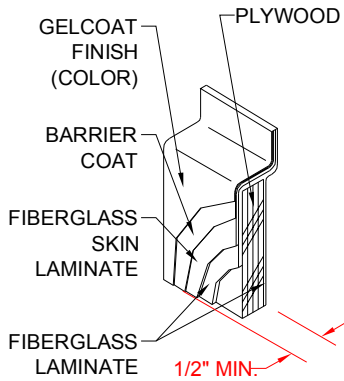

DETAIL B - SCALE: 3" = 1'-0"  
WALL SECTION DETAIL

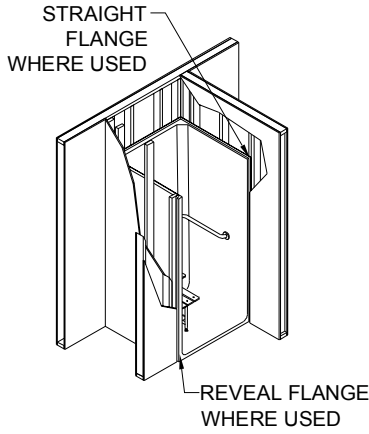

DETAIL C - SCALE: NTS  
TYPICAL FRAMING

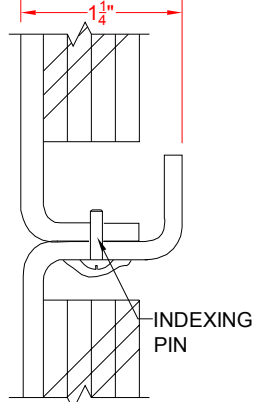

SECTION E - E - SCALE: NTS  
WALL JOINT DETAIL